



LIS302ALB

MEMS motion sensor 3-axis - $\pm 2g$ analog output "piccolo" accelerometer

Features

- 3.0V to 3.6V supply voltage
- ~2mW power consumption
- $\pm 2g$ full-scale
- 3 acceleration channels plus multiplexed analog output
- Ratiometric output voltage
- Power down mode
- Embedded self test
- 10000g high shock survivability
- ECOPACK® RoHS and "Green" compliant (see [Section 6](#))

Description

The LIS302ALB is a miniaturized low-power three-axis linear accelerometer. It includes a sensing element and an IC interface to provide an analog signal to the external world.

The sensing element, capable of detecting the acceleration, is manufactured using a dedicated process developed by ST to produce motion sensors and actuators in silicon.

The IC interface is manufactured using a CMOS process that allows to design a dedicated circuit which is trimmed to better match the sensing element characteristics. The device can be operated from 2.16V to 3.6V.

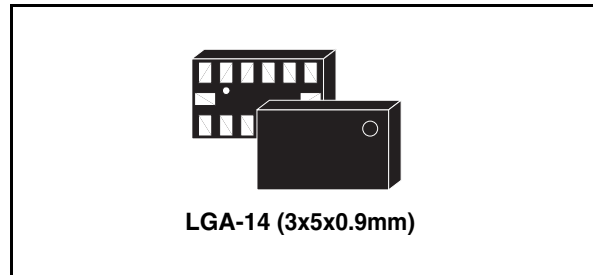

The LIS302ALB has a full scale of $\pm 2g$ and it is capable of measuring accelerations over a maximum bandwidth of 2.0kHz. The device bandwidth may be reduced by using external capacitances. A self-test capability allows the user to check the functioning of the sensor in the final application.

The device has three analog acceleration output plus an embedded multiplexer that allows to redirect the analog outputs onto a single pin for operation with a single channel A/D converter.

The LIS302ALB is available in plastic Thin Land Grid Array package (TLGA) and it is guaranteed to operate over an extended temperature range from -40°C to $+85^{\circ}\text{C}$.

The LIS302ALB belongs to a family of products suitable for a variety of applications:

- Mobile terminals
- Gaming and Virtual Reality input devices
- Free-fall detection for data protection
- Antitheft systems and Inertial Navigation
- Appliance and Robotics.

Order codes

Part number	Temperature range, °C	Package	Packing
LIS302ALB	-40°C to $+85^{\circ}\text{C}$	LGA-14	Tray
LIS302ALBTR	-40°C to $+85^{\circ}\text{C}$	LGA-14	Tape & reel

Note: *Tape & reel parts are compliant to International Standard EIA-481.*

Contents

- 1 Block diagram 3**
 - 1.1 Pin description 3

- 2 Mechanical and electrical specifications 5**
 - 2.1 Mechanical characteristics. 5
 - 2.2 Electrical characteristics 6
 - 2.3 Absolute maximum ratings 7
 - 2.4 Terminology 7

- 3 Functionality 9**
 - 3.1 Sensing element 9
 - 3.2 IC interface 9
 - 3.3 Factory calibration 9

- 4 Application hints 10**
 - 4.1 Soldering information 11
 - 4.2 Output response vs. orientation 11

- 5 Typical performance characteristics 12**
 - 5.1 Mechanical characteristics at 25°C 12
 - 5.2 Mechanical characteristics derived from measurement in the
 -40°C to +85°C temperature range 13
 - 5.3 Electrical characteristics at 25°C 14

- 6 Package information 15**

- 7 Revision history 16**

1 Block diagram

Figure 1. Block diagram

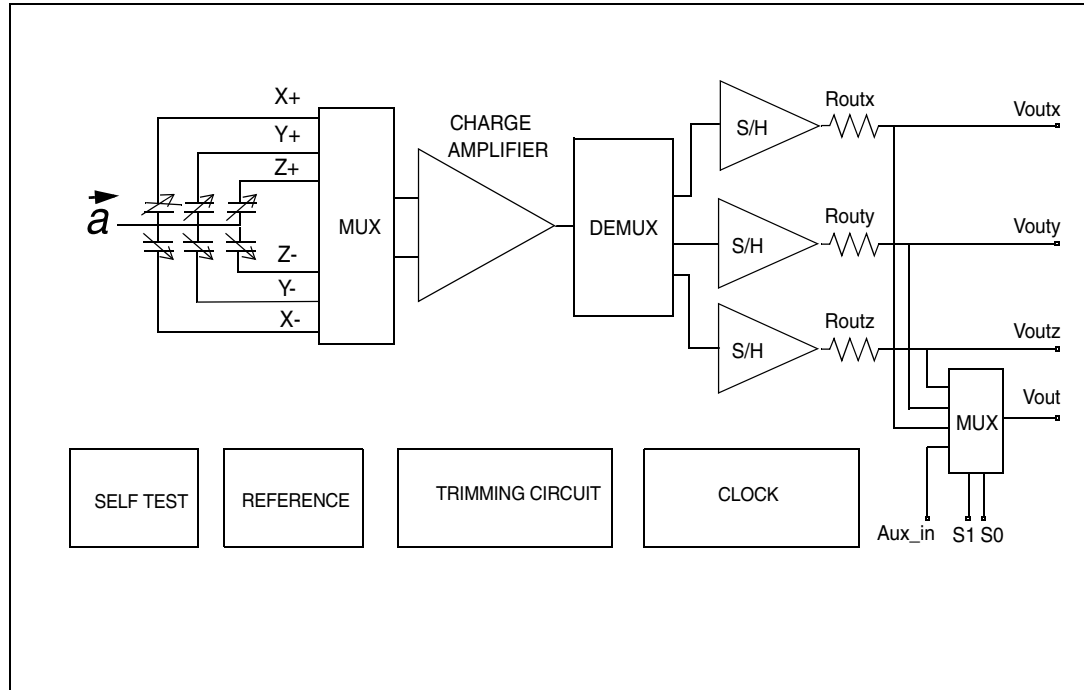

1.1 Pin description

Figure 2. Pin connection

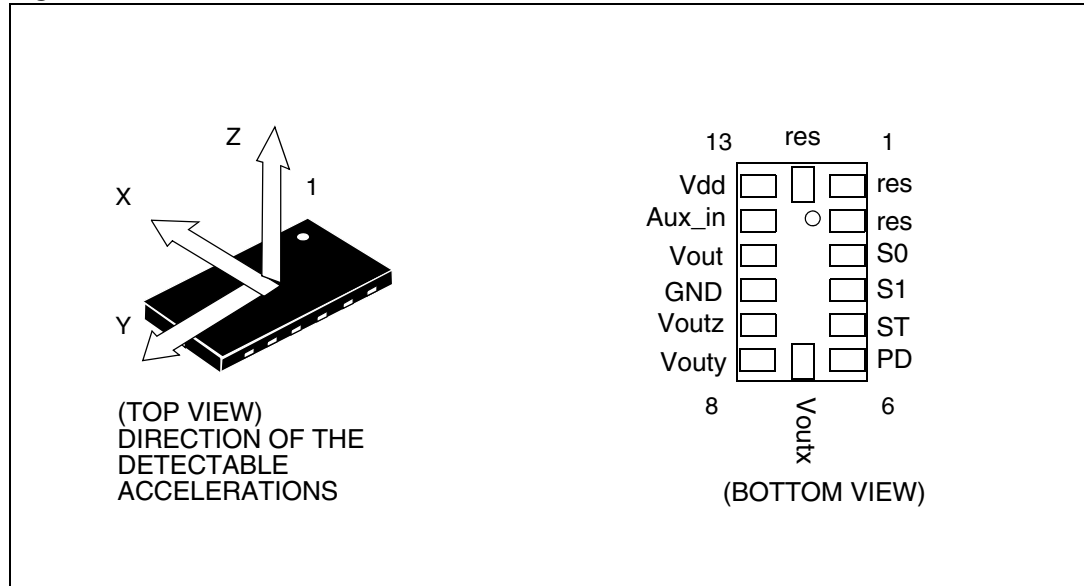

Table 1. Pin description

Pin #	Pin Name	Function
1	Reserved	Connect to Vdd
2	Reserved	Connect to Vdd
3	S0	Mux selector 0 (Connect to Vdd or to GND)
4	S1	Mux selector 1 (Connect to Vdd or to GND)
5	ST	Self Test (Logic 0: normal mode; Logic 1: Self-test)
6	PD	Power Down (Logic 0: normal mode; Logic 1: Power-Down mode)
7	Voutx	Output Voltage X channel
8	Vouty	Output Voltage Y channel
9	Voutz	Output Voltage Z channel
10	GND	0V supply
11	Vout	Multiplexer output
12	Aux_In	Auxiliary input
13	Vdd	Power supply
14	Reserved	Connect to Vdd

2 Mechanical and electrical specifications

2.1 Mechanical characteristics.

Table 2. Mechanical characteristics⁽¹⁾

All parameters are specified @ Vdd =3.3V, T = 25°C unless otherwise noted

Symbol	Parameter	Test Condition	Min.	Typ. ⁽²⁾	Max.	Unit
Ar	Acceleration range ⁽³⁾			±2.0		g
So	Sensitivity ⁽⁴⁾		0.145*Vdd -5%	0.145*Vdd	0.145*Vdd + 5%	V/g
SoDr	Sensitivity change Vs Temperature	Delta from +25°C		±0.01		%/°C
Voff	Zero-g level ⁽⁴⁾	T = 25°C	Vdd/2-6%	Vdd/2	Vdd/2+6%	V
OffDr	Zero-g level change Vs Temperature	Delta from +25°C		±0.5		mg/°C
NL	Non Linearity ⁽⁵⁾	Best fit straight line		±0.5		% FS
CrossAx	Cross-Axis ⁽⁶⁾			±2		%
An	Acceleration Noise Density	Vdd=3.3V		200		µg/√Hz
Vt	Self test output voltage change ^{(7),(8)}	T = 25°C Vdd=3.3V X axis	+95		+200	mV
		T = 25°C Vdd=3.3V Y axis	+95		+200	mV
		T = 25°C Vdd=3.3V Z axis	+95		+200	mV
Fres	Sensing Element Resonant Frequency ⁽⁹⁾	all axes	2.0			kHz
Top	Operating Temperature Range		-40		+85	°C
Wh	Product Weight			30		mgram

1. The product is factory calibrated at 3.3V. The operational power supply range is specified in table 3. Since the device is ratiometric Voff, So and Vt parameters will vary with supply voltage.
2. Typical specifications are not guaranteed
3. Guaranteed by wafer level test and measurement of initial offset and sensitivity
4. Zero-g level and sensitivity are ratiometric to supply voltage
5. Guaranteed by design
6. Contribution to the measuring output of an inclination/acceleration along any perpendicular axis
7. Self test output voltage change" is defined as $V_{out}(V_{st=Logic1}) - V_{out}(V_{st=Logic0})$
8. Self test output voltage change" varies cubically with supply voltage
9. Minimum resonance frequency $F_{res}=2.0kHz$. Sensor bandwidth= $1/(2*\pi*32k\Omega*Cl_{load})$

2.2 Electrical characteristics

Table 3. Electrical characteristics⁽¹⁾

All parameters are specified @ Vdd =3.3V, T=25°C unless otherwise noted

Symbol	Parameter	Test Condition	Min.	Typ. ⁽²⁾	Max.	Unit
Vdd	Supply Voltage		3.0	3.3	3.6	V
Idd	Supply Current	mean value PD pin connected to GND		0.65		mA
IddPdn	Supply Current in Power Down Mode	PD pin connected to Vdd		1		μA
Vst	Self Test Input	Logic 0 level at Vdd=3.3V	0		0.8	V
		Logic 1 level at Vdd=3.3V	2.0		Vdd	V
Rout	Output impedance of Voutx, Vouty, Voutz			32		kΩ
Cload	Capacitive Load Drive for Voutx, Vouty, Voutz ⁽³⁾		2.5			nF
Vs0	S0 Input	Logic 0 level at Vdd=3.3V	0		0.8	V
		Logic 1 level at Vdd=3.3V	2.0		Vdd	V
Vs1	S1 input	Logic 0 level at Vdd=3.3V	0		0.8	V
		Logic 1 level at Vdd=3.3V	2.0		Vdd	V
Rmux	Series resistance of multiplexer input Vs Vout			1		kΩ
Cloadmux	Capacitive load drive for multiplexed output Vout			10		pF
Ton	Turn-On Time at exit from Power Down mode	Cloud in μF		160*Cloud+0.3		ms
Top	Operating Temperature Range		-40		+85	°C

1. The product is factory calibrated at 3.3V. For availability of different supply voltage in the maximum range [2.16V, 3.6V] contact factory
2. Typical specifications are not guaranteed
3. Minimum resonance frequency $F_{res}=2.0\text{kHz}$. Device bandwidth= $1/(2*\pi*32\text{k}\Omega*Cloud)$

2.3 Absolute maximum ratings

Stresses above those listed as “absolute maximum ratings” may cause permanent damage to the device. This is a stress rating only and functional operation of the device under these conditions is not implied. Exposure to maximum rating conditions for extended periods may affect device reliability.

Table 4. Absolute maximum ratings

Symbol	Ratings	Maximum Value	Unit
Vdd	Supply voltage	-0.3 to 6	V
Vin	Input Voltage on Any Control pin (PD, ST)	-0.3 to Vdd +0.3	V
V _{Aux_in}	Aux_in Input Voltage	-0.3 to Vdd +0.3	V
A _{POW}	Acceleration (Any axis, Powered, Vdd=3.3V)	3000g for 0.5 ms	
		10000g for 0.1 ms	
A _{UNP}	Acceleration (Any axis, Not powered)	3000g for 0.5 ms	
		10000g for 0.1 ms	
T _{STG}	Storage Temperature Range	-40 to +150	°C
ESD	Electrostatic Discharge Protection	2 (HBM)	KV
		1.5 (CDM)	KV
		200 (MM)	V



This is a Mechanical Shock sensitive device, improper handling can cause permanent damages to the part



This is an ESD sensitive device, improper handling can cause permanent damages to the part

2.4 Terminology

Sensitivity describes the gain of the sensor and can be determined by applying 1g acceleration to it. As the sensor can measure DC accelerations this can be done easily by pointing the axis of interest towards the center of the earth, note the output value, rotate the sensor by 180 degrees (point to the sky) and note the output value again thus applying $\pm 1g$ acceleration to the sensor. Subtracting the larger output value from the smaller one and dividing the result by 2 will give the actual sensitivity of the sensor. This value changes very little over temperature (see sensitivity change vs. temperature) and also very little over time. The Sensitivity Tolerance describes the range of Sensitivities of a large population of sensors.

Zero-g level describes the actual output signal if there is no acceleration present. A sensor in a steady state on a horizontal surface will measure 0g in X axis and 0g in Y axis whereas the Z axis will measure +1g. The output is ideally for a 3.3V powered sensor $V_{dd}/2 = 1650mV$. A deviation from ideal 0-g level (1650mV in this case) is called Zero-g offset. Offset of precise MEMS sensors is to some extent a result of stress to the sensor and therefore the offset can slightly change after mounting the sensor onto a printed circuit board or exposing it to extensive mechanical stress. Offset changes little over temperature - see “Zero-g level change vs. temperature” - the Zero-g level of an individual sensor is very stable

over lifetime. The Zero-g level tolerance describes the range of Zero-g levels of a population of sensors.

Self Test allows to check the sensor functionality without moving it. The Self Test function is off when the ST pin is connected to GND. When the ST pin is tied at Vdd an actuation force is applied to the sensor, simulating a definite input acceleration. In this case the sensor outputs will exhibit a voltage change in their DC levels which is related to the selected full scale and depending on the Supply Voltage through the device sensitivity. When ST is activated, the device output level is given by the algebraic sum of the signals produced by the acceleration acting on the sensor and by the electrostatic test-force. If the output signals change within the amplitude specified inside Table 2, than the sensor is working properly and the parameters of the interface chip are within the defined specification.

Output impedance describes the resistor inside the output stage of each channel. This resistor is part of a filter consisting of an external capacitor of at least 2.5nF and the internal resistor. Due to the resistor level, only small inexpensive external capacitors are needed to generate low corner frequencies. When interfacing with an ADC it is important to use high input impedance input circuitries to avoid measurement errors. Note that the minimum load capacitance forms a corner frequency close to the resonance frequency of the sensor. In general the smallest possible bandwidth for a particular application should be chosen to get the best results.

3 Functionality

The LIS302ALB is an “piccolo” low-power, analog output three-axis linear accelerometer packaged in a LGA package. The complete device includes a sensing element and an IC interface able to take the information from the sensing element and to provide an analog signal to the external world. The sensor provides the three accelerations and one multiplexed analog output.

3.1 Sensing element

A proprietary process is used to create a surface micro-machined accelerometer. The technology allows to carry out suspended silicon structures which are attached to the substrate in a few points called anchors and are free to move in the direction of the sensed acceleration. To be compatible with the traditional packaging techniques a cap is placed on top of the sensing element to avoid blocking the moving parts during the moulding phase of the plastic encapsulation.

When an acceleration is applied to the sensor the proof mass displaces from its nominal position, causing an imbalance in the capacitive half-bridge. This imbalance is measured using charge integration in response to a voltage pulse applied to the sense capacitor.

At steady state the nominal value of the capacitors are few pF and when an acceleration is applied the maximum variation of the capacitive load is in fF range.

3.2 IC interface

The complete signal processing uses a fully differential structure, while the final stage converts the differential signal into a single-ended one to be compatible with the external world.

The first stage is a low-noise capacitive amplifier that implements a Correlated Double Sampling (CDS) at its output to cancel the offset and the $1/f$ noise. The produced signal is then sent to three different S&Hs, one for each channel, and made available to the outside.

The device provides an embedded multiplexer to allow the redirection of either the analog output signals V_{outx} , V_{outy} , and V_{outz} or of an auxiliary input signal onto a single pin for operation with a single channel A/D converter.

All the analog parameters (output offset voltage and sensitivity) are ratiometric to the voltage supply. Increasing or decreasing the voltage supply, the sensitivity and the offset will increase or decrease linearly. The feature provides the cancellation of the error related to the voltage supply along an analog to digital conversion chain.

The product is factory calibrated at 3.3V. For availability of different supply voltage in the maximum range [2.16V, 3.6V] contact factory

3.3 Factory calibration

The IC interface is factory calibrated for sensitivity (S_o) and Zero-g level (V_{off}). The trimming values are stored inside the device in a non volatile structure. Any time the device is turned on, the trimming parameters are downloaded into the registers to be employed during the normal operation. This allows the user to employ the device without further calibration.

4 Application hints

Figure 3. LIS302ALB electrical Connection

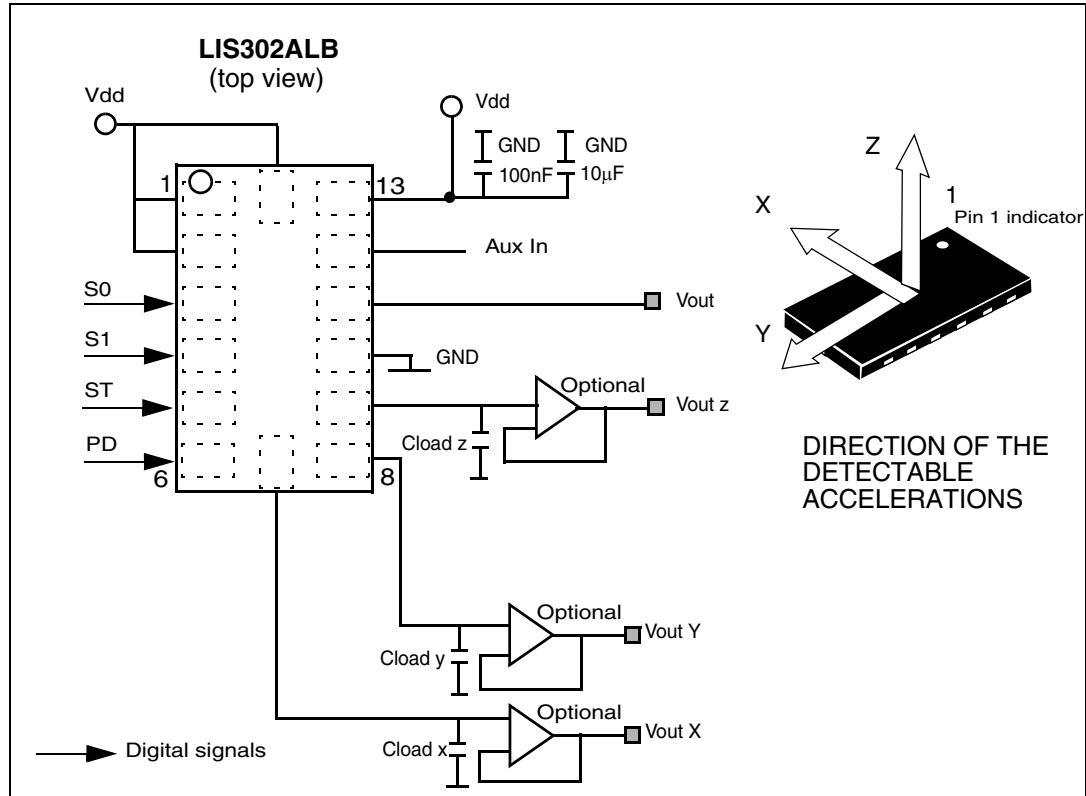

Power supply decoupling capacitors (100nF ceramic or polyester + 10µF Aluminum) should be placed as near as possible to the device (common design practice).

The LIS302ALB allows to band limit Voutx, Vouty and Voutz through the use of external capacitors. The recommended frequency range spans from DC up to 2.0kHz. Capacitors must be added at output pins to implement low-pass filtering for antialiasing and noise reduction. The equation for the cut-off frequency (f_t) of the external filters is:

$$f_t = \frac{1}{2\pi \cdot R_{out} \cdot C_{load}(x, y, z)}$$

Taking into account that the internal filtering resistor (R_{out}) has a nominal value equal to 32kΩ, the equation for the external filter cut-off frequency may be simplified as follows:

$$f_t = \frac{5\mu F}{C_{load}(x, y, z)} [Hz]$$

The tolerance of the internal resistor can vary typically of ±20% within its nominal value of 32kΩ; thus the cut-off frequency will vary accordingly. A minimum capacitance of 2.5nF for $C_{load}(x, y, z)$ is required in any case.

An external capacitor can be added to the Vout pin. Values below 10 pF are recommended.

Table 5. Filter capacitor selection, $C_{load}(x,y,z)$

Cut-off frequency	Capacitor value
1 Hz	5 μ F
10 Hz	0.5 μ F
20 Hz	250nF
50 Hz	100nF
100 Hz	50nF
200 Hz	25nF
500 Hz	10nF

Table 6. MUX I/O table

S1 pin	S0 pin	MUX status
0	0	Vout=Vout X
0	1	Vout=Vout Y
1	0	Vout=Vout Z
1	1	Vout=Aux_in

4.1 Soldering information

The LGA package is compliant with the ECOPACK, RoHs and “Green” standard. It is qualified for soldering heat resistance according to JEDEC J-STD-020C.

Pin1 indicator is electrically connected to pin 1. Leave pin 1 indicator unconnected during soldering. Land pattern and soldering recommendations are available at www.st.com/mems.

4.2 Output response vs. orientation

Figure 4. Output Response vs. Orientation

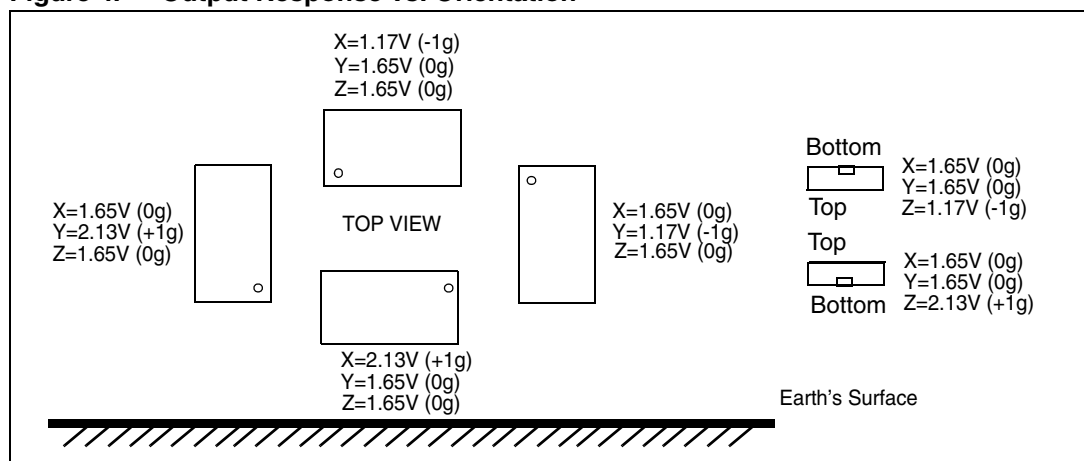

Figure 4 refers to LIS302ALB powered at 3.3V.

5 Typical performance characteristics

5.1 Mechanical characteristics at 25°C

Figure 5. X-axis Zero-g level and Sensitivity at 3.3V

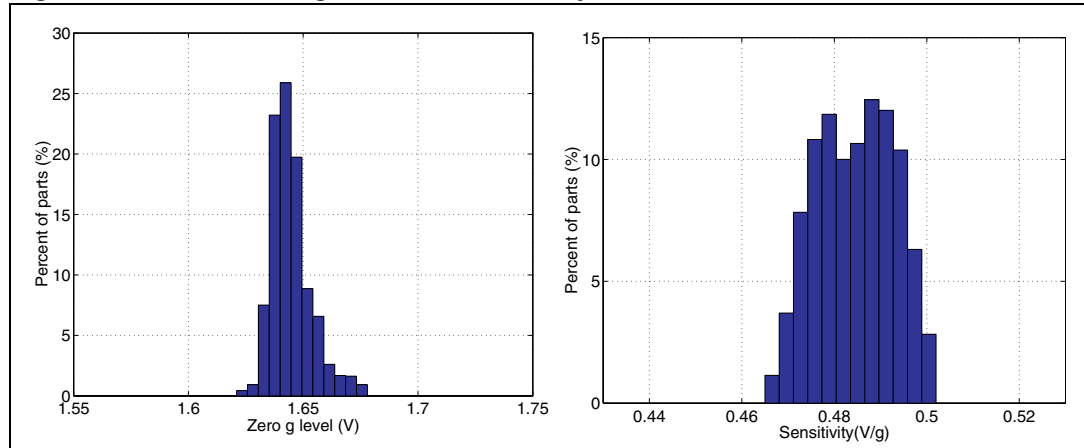

Figure 6. Y-axis Zero-g level and Sensitivity at 3.3V

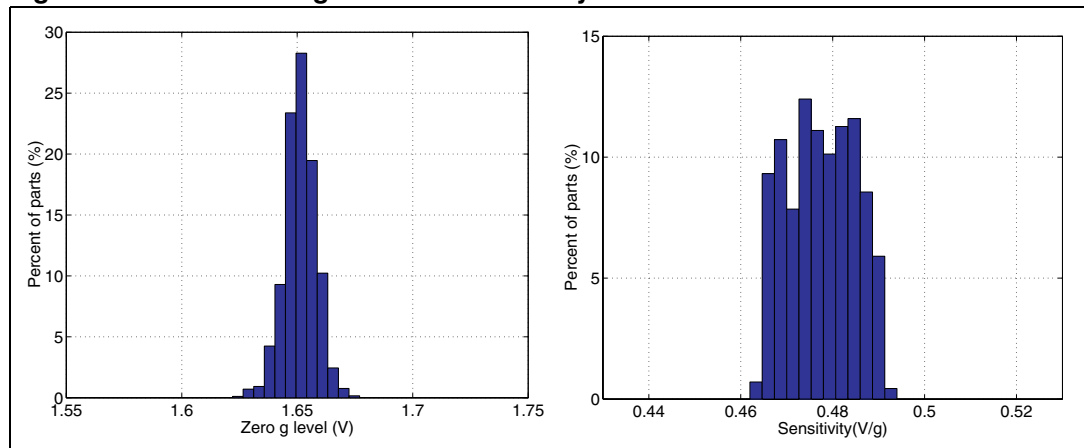
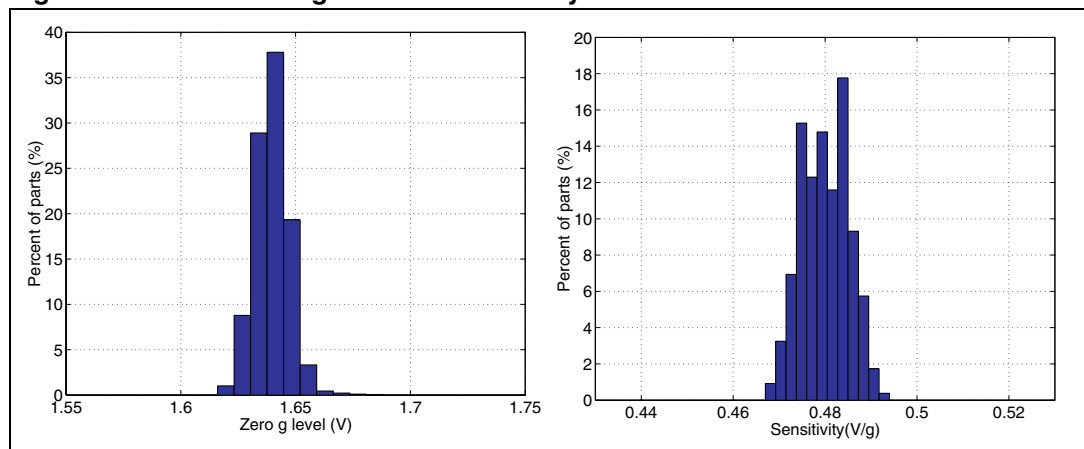

Figure 7. Z-axis Zero-g level and Sensitivity at 3.3V



5.2 Mechanical characteristics derived from measurement in the -40°C to +85°C temperature range

Figure 8. X-axis Zero-g level and Sensitivity change Vs temperature

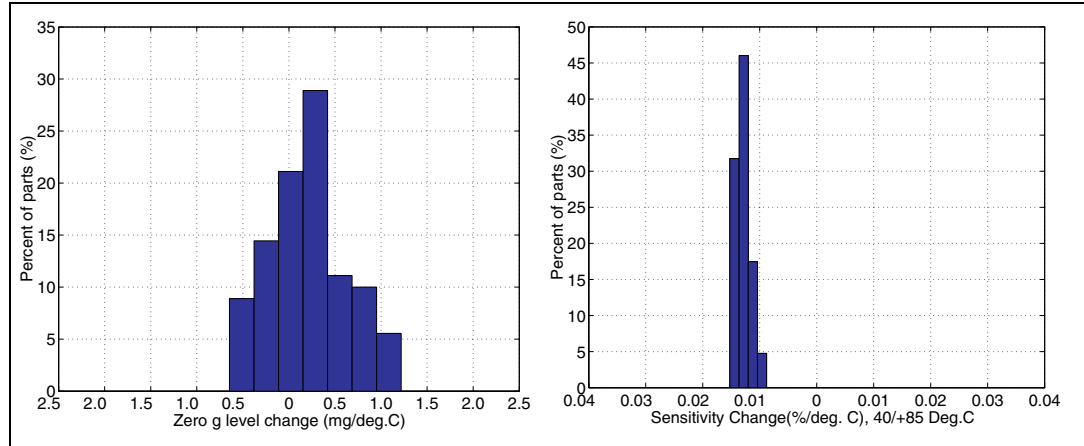

Figure 9. Y-axis Zero-g level and Sensitivity change Vs temperature

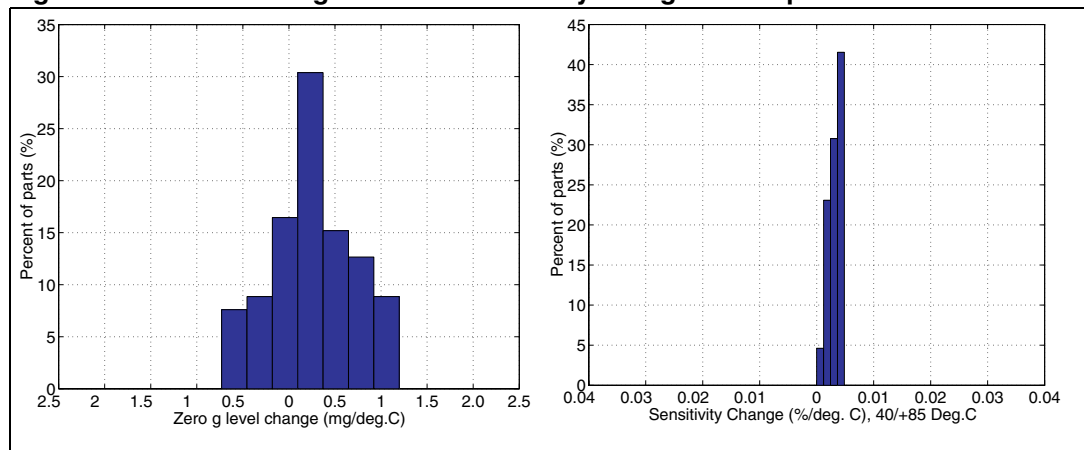
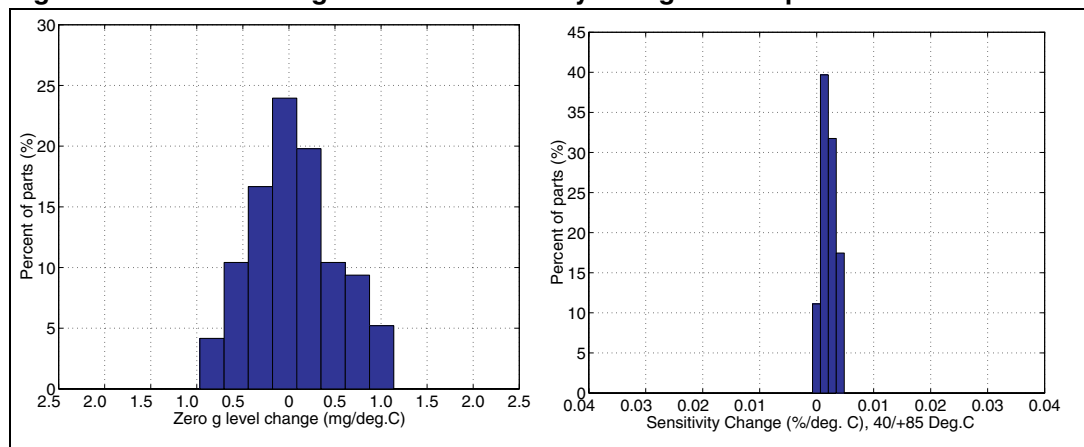
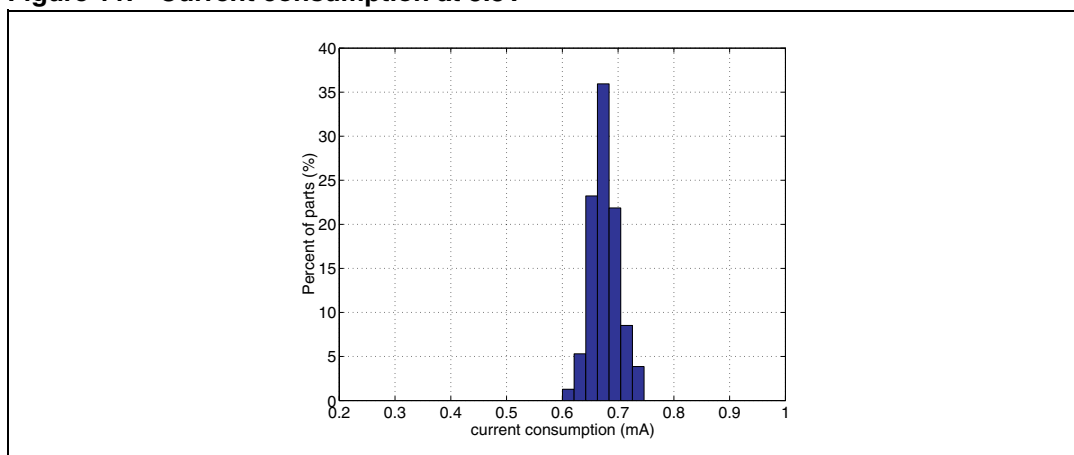

Figure 10. Z-axis Zero-g level and Sensitivity change Vs temperature



5.3 Electrical characteristics at 25°C

Figure 11. Current consumption at 3.3V



6 Package information

In order to meet environmental requirements, ST offers these devices in ECOPACK® packages. These packages have a Lead-free second level interconnect. The category of second Level Interconnect is marked on the package and on the inner box label, in compliance with JEDEC Standard JESD97. The maximum ratings related to soldering conditions are also marked on the inner box label. ECOPACK is an ST trademark.

ECOPACK specifications are available at: www.st.com.

Figure 12. LGA 14: Mechanical Data & Package Dimensions

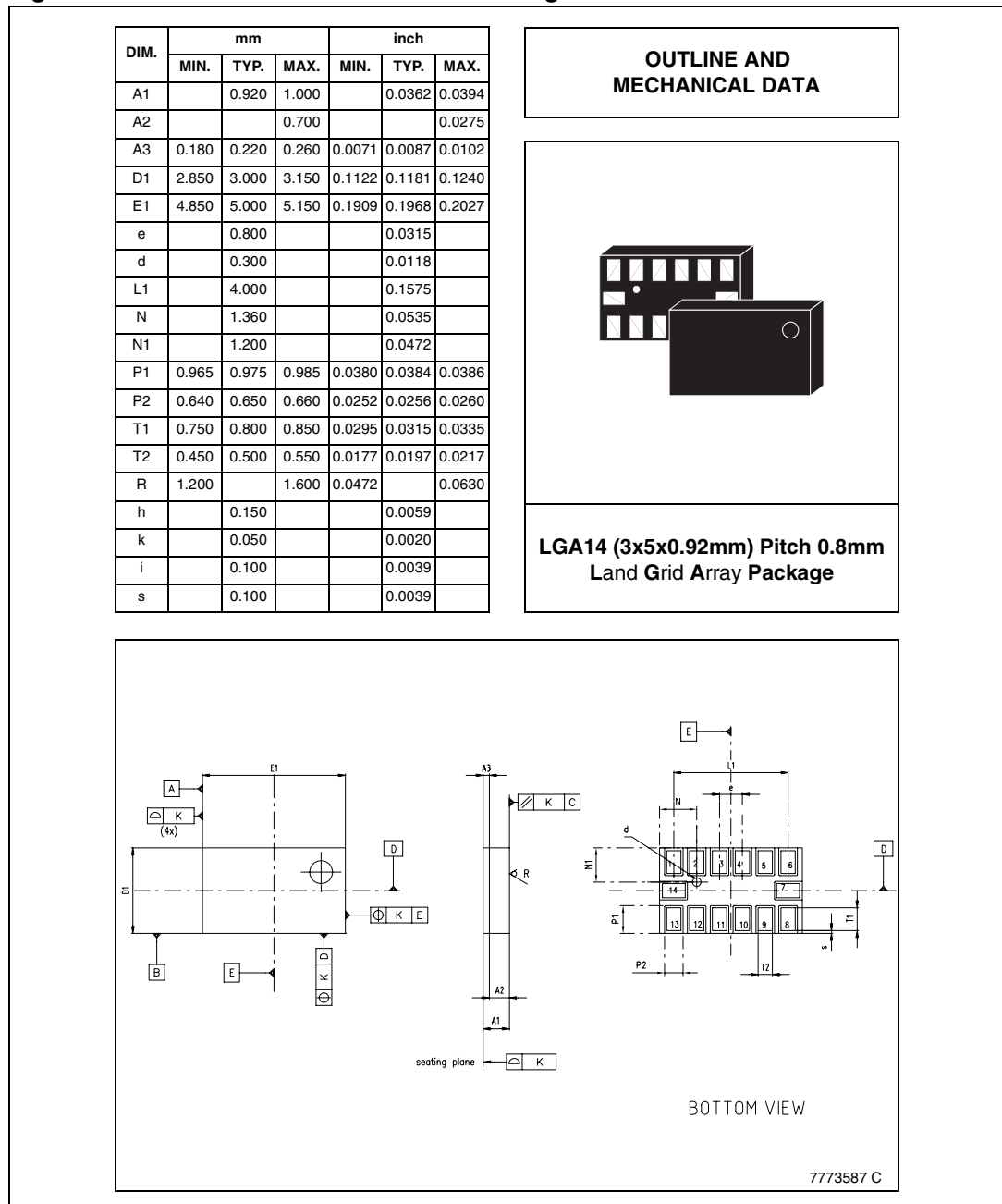

7 Revision history

Table 7. Document revision history

Date	Revision	Changes
03-Oct-2006	1	Initial release.

Please Read Carefully:

Information in this document is provided solely in connection with ST products. STMicroelectronics NV and its subsidiaries ("ST") reserve the right to make changes, corrections, modifications or improvements, to this document, and the products and services described herein at any time, without notice.

All ST products are sold pursuant to ST's terms and conditions of sale.

Purchasers are solely responsible for the choice, selection and use of the ST products and services described herein, and ST assumes no liability whatsoever relating to the choice, selection or use of the ST products and services described herein.

No license, express or implied, by estoppel or otherwise, to any intellectual property rights is granted under this document. If any part of this document refers to any third party products or services it shall not be deemed a license grant by ST for the use of such third party products or services, or any intellectual property contained therein or considered as a warranty covering the use in any manner whatsoever of such third party products or services or any intellectual property contained therein.

UNLESS OTHERWISE SET FORTH IN ST'S TERMS AND CONDITIONS OF SALE ST DISCLAIMS ANY EXPRESS OR IMPLIED WARRANTY WITH RESPECT TO THE USE AND/OR SALE OF ST PRODUCTS INCLUDING WITHOUT LIMITATION IMPLIED WARRANTIES OF MERCHANTABILITY, FITNESS FOR A PARTICULAR PURPOSE (AND THEIR EQUIVALENTS UNDER THE LAWS OF ANY JURISDICTION), OR INFRINGEMENT OF ANY PATENT, COPYRIGHT OR OTHER INTELLECTUAL PROPERTY RIGHT.

UNLESS EXPRESSLY APPROVED IN WRITING BY AN AUTHORIZED ST REPRESENTATIVE, ST PRODUCTS ARE NOT RECOMMENDED, AUTHORIZED OR WARRANTED FOR USE IN MILITARY, AIR CRAFT, SPACE, LIFE SAVING, OR LIFE SUSTAINING APPLICATIONS, NOR IN PRODUCTS OR SYSTEMS WHERE FAILURE OR MALFUNCTION MAY RESULT IN PERSONAL INJURY, DEATH, OR SEVERE PROPERTY OR ENVIRONMENTAL DAMAGE. ST PRODUCTS WHICH ARE NOT SPECIFIED AS "AUTOMOTIVE GRADE" MAY ONLY BE USED IN AUTOMOTIVE APPLICATIONS AT USER'S OWN RISK.

Resale of ST products with provisions different from the statements and/or technical features set forth in this document shall immediately void any warranty granted by ST for the ST product or service described herein and shall not create or extend in any manner whatsoever, any liability of ST.

ST and the ST logo are trademarks or registered trademarks of ST in various countries.

Information in this document supersedes and replaces all information previously supplied.

The ST logo is a registered trademark of STMicroelectronics. All other names are the property of their respective owners.

© 2006 STMicroelectronics - All rights reserved

STMicroelectronics group of companies

Australia - Belgium - Brazil - Canada - China - Czech Republic - Finland - France - Germany - Hong Kong - India - Israel - Italy - Japan - Malaysia - Malta - Morocco - Singapore - Spain - Sweden - Switzerland - United Kingdom - United States of America

www.st.com

